

HPS Controls Ltd.

Series 200

HTP

Zone Control Stations

**Heating and Radiant Floor
Zone Control Stations**

Installation Instructions



Thank you for purchasing the finest in heating and radiant floor Control Stations. We are confident that you will enjoy years of trouble free service from this Station. As with any product requiring specific installation guidelines, a good understanding of **ALL** the system components and final product is necessary to achieve the optimum results. This manual has been kept as short and uncomplicated as possible.

**Please read the entire manual before
beginning your installation**

HPS Controls Ltd.

Series 200 HTP

| Table of Contents | Page |
|--|-------------|
| Applications & Features | 2 |
| Zone Control Stations | 2 |
| High Temperature Zones | 2 |
| Circuit Board Technology | 2 |
| Zone Control Station Installation | 3 |
| Important..... | 3 |
| Installation Instructions | 3 |
| Wiring a Panel..... | 4 |
| Main Power Supply | 4 |
| Thermostats..... | 4 |
| Dry Contact for Boiler | 4 |
| Timer Settings..... | 5 |
| Zone Priorities..... | 5 |
| Printed Circuit Board Caution | 5 |
| System / Station Purging..... | 6 |
| Removing Air from the System | 6 |
| If using a Floor Drain | 6 |
| Cold Weather Startup Caution | 6 |
| Powering up the Station | 7 |
| Instructions | 7 |
| Main Pump Connections..... | 7 |
| Diagram A (Generic Hydronic Heating Schematic) | 8 |
| Diagram B (2-Zone Hydronic Controller)..... | 9 |
| Diagram C (4-Zone Hydronic Controller) | 10 |
| Diagram D (HTP Series) | 11 |
| Grundfos Pump Curves..... | 12 |
| Warranty..... | 13 |

Continued on next page

HPS Controls Ltd. Series 200 HTP

Applications & Features

Zone Control Stations

- Consist of a pre-piped and pre-wired unit to be used with Primary/Secondary piped hydronic systems.
 - Available with “High” temperature zones, and is supplied with up to four circulator pumps.
 - Each circulator pump is able to operate a specific zone each independent of each other.
-

High Temperature Zones

Used for:

- Fancoils
 - Indirect Hot Water Tanks
 - Base Board heating
-

Circuit Board Technology

New circuit board technology enables the optimum in complete boiler system control, and simplifies wiring of the system.

Features within the circuit board include:

- boiler control contacts
 - various timer settings for pump exercise
 - zone one priority setting
-

Continued on next page

HPS Controls Ltd. Series 200 HTP

Zone Control Station Installation

Important

All local code requirements must be followed.
Contact your Local Plumbing Inspection Department for requirements necessary for your area.

Installation Instructions

Refer to your shipping list and confirm that all of the components have been received and are undamaged. If you received damaged material, please notify the freight forwarder and the supplier immediately.

1. Install the Zone Control Station close to the heating appliance to simplify the piping installation.
 - Fasten the Station to the wall using a minimum of 4 - #10 size screws.
 - When possible fasten a wood backing of either 2x4 or plywood in place to support the HTP Station.
 - Attach a 2x4 to the wall for resting the station from underneath to hold the station when mounting. Remove after mounting.
 2. The "Main Supply" and "Main Return" lines to the Zone Control Station vary from 3/4" to 1 1/4" depending on the number of zones.
 - Ball valves of corresponding size **must** be installed on the main **supply and return** line to isolate it from the boilers primary loop. This will assist in purging of the system.
 - The secondary supply and return pipes to the Station should be installed **no more** than 4 (Primary loop) pipe diameters apart when leaving and returning to the Primary loop.
 - The individual zone supply and return lines are 3/4" copper for all stations.
 3. Measure the tube or copper pipe length required for both the supply and return lines from the station to the manifolds and install. Measure each zone separately.
 4. If using "Pex" pipe, cut tubing longer (4" to 6"). Trim before the final connection.
-

Caution

The "main supply" and "main return" connections on the station are designed to be piped into the boiler system as the "**SECONDARY**" piping.

- The whole operation of the Zone Control Station is designed around Primary/Secondary piping.
- If the Zone Control Station is installed in any other manner, it may not operate properly and this will void any warranty.

Refer to Diagram "A" which shows an example of a Zone Control Station installed in a Primary/Secondary manner.

Continued on next page

HPS Controls Ltd. Series 200 HTP

Wiring a Panel

Refer to Diagrams “B and C” for illustrated circuit boards.

Main Power Supply

Each Zone Control Station comes complete with a:

- Printed Circuit Board
 - Main Disconnect Switch (except LTV-1 & LTV-2)
- Both are located in the top left hand corner of the Station.

The Zone Control Station is designed to use 110V/60HZ/1PH power supply.

The power must be connected to the factory installed black and white line voltage wires, and ground wire attached to the green wire.

Thermostats

The thermostats(24v) are wired directly to the circuit board.

- On the larger stations, there is a total of four thermostat connections on the board, each corresponding to a specific zone.
- When the connections are closed between terminals “R” and “W1”, pump number 1 will be energized. The same applies for zones 2 thru 4 if equipped. An 18-2 LVT thermostat wire be installed.
- Thermostats that require 24 volts AC, terminal connections “R” and “C” must be used. An 18-3 LVT thermostat wire must be installed.

Within the building, locate the thermostats in the desired location of the zone on an inside wall. The thermostat must be located where it will not be affected by heat sources such as a fireplace, TV, sun, or heat/ventilation duct.

Note: Check that the thermostat heat anticipator is set for 0.25 amps.

Dry Contact for Boiler

The “Boiler” terminals can be used in series with the Boiler Control Circuit to turn on the boiler when only a need for heat arises. This can save on costly standby losses from the boiler firing for no reason.

These contacts should be wired to the boiler thermostat terminals.

Some boilers may not be equipped with thermostat terminals.

- If this is the case, the dry contact terminals can be wired in series with the control circuitry of the boiler (i.e. gas valve).
 - While any pump is activated, the “Dry Contacts to Boiler” terminals on the Circuit Board will close. This in turn will send a signal to the boiler that there is a demand for heat, and the boiler should fire according to the temperature setting on the boiler aquastat or outdoor reset control.
-

Continued on next page

HPS Controls Ltd. Series 200 HTP

Wiring a Panel, Continued

Other features of the Circuit Board that *do not* have to be field wired

Timer Settings

To prolong the life of the circulators within the HTP Station, it is equipped with pump exercise timers.

- There are four different timer settings that can be chosen depending on preference.
- The various timing settings are set by adding or removing H2 & H3 on the circuit board.
Refer to Circuit Board Diagrams “B and C” for the different timer settings available.

When the timer is activated, it will cycle all pumps within the station.

Zone Priorities

A jumper wire is located in the centre of the circuit board.

- If this jumper wire is removed from the circuit board it will enable Zone 1 as a “priority” zone.
- If used, this feature will shut down Zones 2 thru 4 if there is a demand on Zone 1.

This feature would be used if Zone 1 was being used as a “high” temperature zone with an indirect hot water heater.

This would direct all of the boilers capacity into heating the domestic water, which in turn would result in a higher recovery rate.

Printed Circuit Board Caution

The Printed Circuit Board is protected by an internal Polyswitch or Overcurrent protection device. If the switch trips, it will automatically reset itself over a short period of time. There are no fuses on this board.

A multimeter must be used for all testing required.

Continued on next page

HPS Controls Ltd. Series 200 HTP

System / Station Purging

Refer to Diagrams "D" for illustrated Zone Stations.

Removing Air from the System

All the air in the system must be removed during the filling of the system, by purging each circuit of each zone independently in turn. The larger Zone Control Stations come equipped with a hose bib purge valve.

1. Place a garden hose on the purge valve within the Station, run to a convenient drain, and open the purge valve.
2. Close the ball valve on the main return to the boiler primary loop.
3. Close all ball valves on all zone supplies and zone returns.
4. Open Zone #1 supply and return ball valves. Allow the water to flow through Zone #1 until the water coming out from the hose has no air showing.

Continue this for each circuit, purging one zone at a time.

Close all the circuits after purging so that only one circuit flows at a time.

5. When all zones have been filled and purged:
 - Close both supply and return valves to the station
 - Purge the boilers primary loop

In some instances, if running a zone supply to a distribution manifold for in-floor piping, purge each individual floor loop before purging back to the panel.

6. After the piping to the boiler has been filled and purged, open all valves.
 7. Open the valves at the Zone Control Station supply and returns, and all valves at the zone manifolds.
-

If using a Floor Drain

Place the hose into the floor drain approximately 3" to 4" below the water line to allow for the bubbles to be seen as they rise to the surface. Doing the purging procedure twice will reduce the chance of air in the system.

Cold Weather Startup Caution

When doing cold weather start up, it is possible that areas of the slab may be below freezing even with temporary heat being provided.

The system must not be filled and purged until it is ready to have the system circulating with the boiler in operation applying heat to the slab.

Depending on the starting temperature of the slab, it may take hours to days for the slab to reach radiant floor operational temperature due to the large thermal mass.

Continued on next page

HPS Controls Ltd. Series 200 HTP

Powering up the Station

Instructions To power up the station follow these instructions:

1. Turn on the power from the main electrical disconnect.
2. Turn on the ON/OFF switch located on the Zone Control Station.
3. Be sure the power indicator light is ON, showing power to the Zone Control Station.

Note: Model HTP-1 does not have an ON/OFF switch or indicator light.

Note: Any time power is applied to the Zone Control Station the timer system will activate if the jumper on the circuit board is in the ON position.

4. Check that the L5-LED light on the circuit board is **flashing**. This is the Normal Condition.
If light is ON continuously, this is an Abnormal Condition.
 - Circuit Board may need to be replaced.If light is OFF, this is also an Abnormal Condition.
 - Check 2AMP Fuse on the Circuit Board.
5. Wait for the pump timer override period to finish. Turn up the thermostat for each zone in turn. Confirm that each zone is operating properly.
 - On a demand from the thermostat, the circulator will start, giving flow to the specified zone.
 - The LED light for each zone will light up on the Circuit Board.

Note:

To troubleshoot possible problems, check operating temperature of pumps. If a pump seems to be running much hotter than any of the others, there may be too much head pressure within that zone or the zone may be air locked.

**Main Pump
Connections**

If the boiler cannot supply power to the primary loop circulator, connect the primary circulator to “Neutral” and “N/O “ using #14 gauge copper conductors.

This will supply 115 volts AC to the primary circulator when any zone circulator within the station is energized.

Continued on next page

HPS Controls Ltd. Series 200 HTP

Diagram A (Generic Hydronic Heating Schematic)

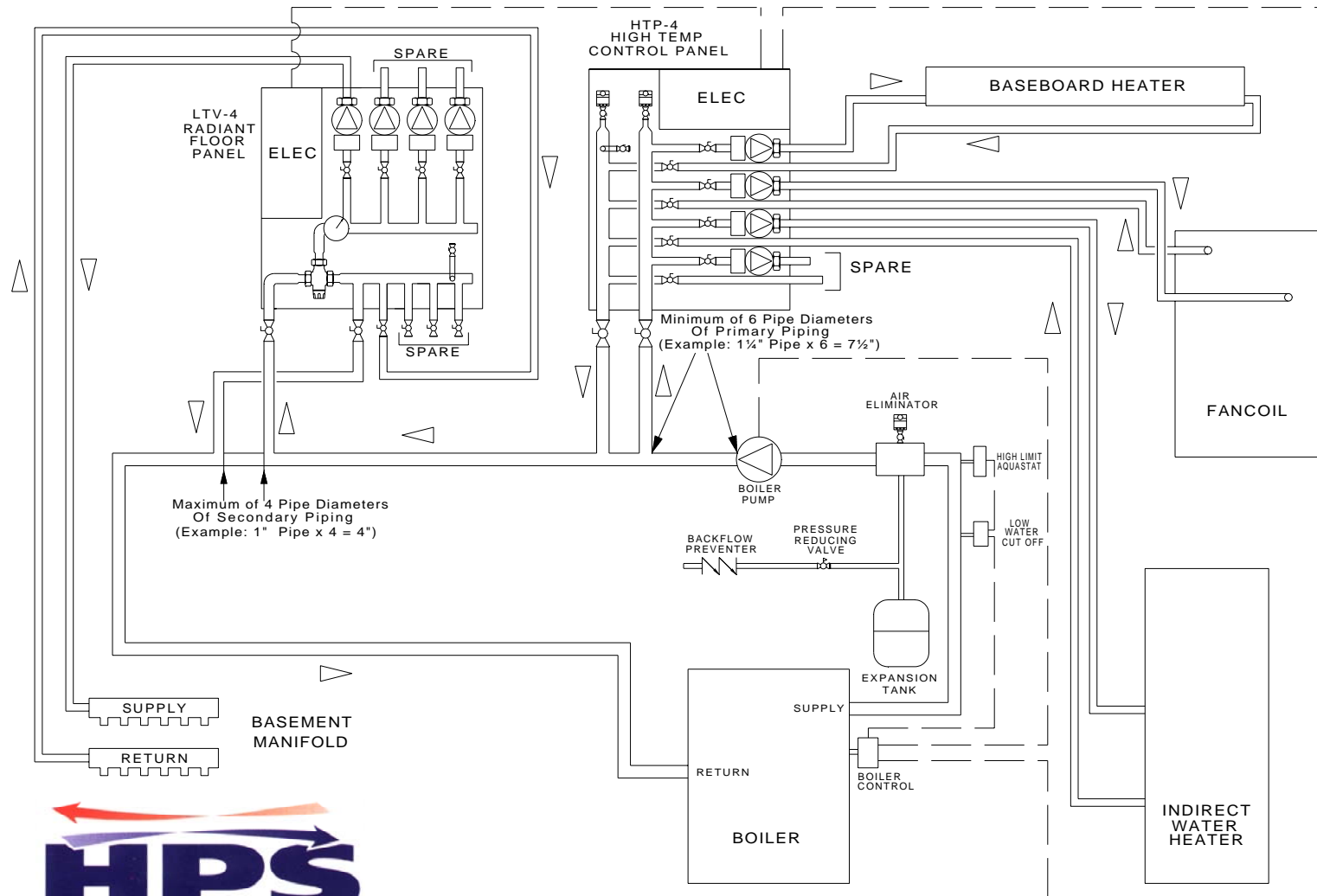

GENERIC HYDRONIC HEATING SCHEMATIC

HPS Controls Ltd. Series 200 HTP

Diagram B (2-Zone Hydronic Controller)

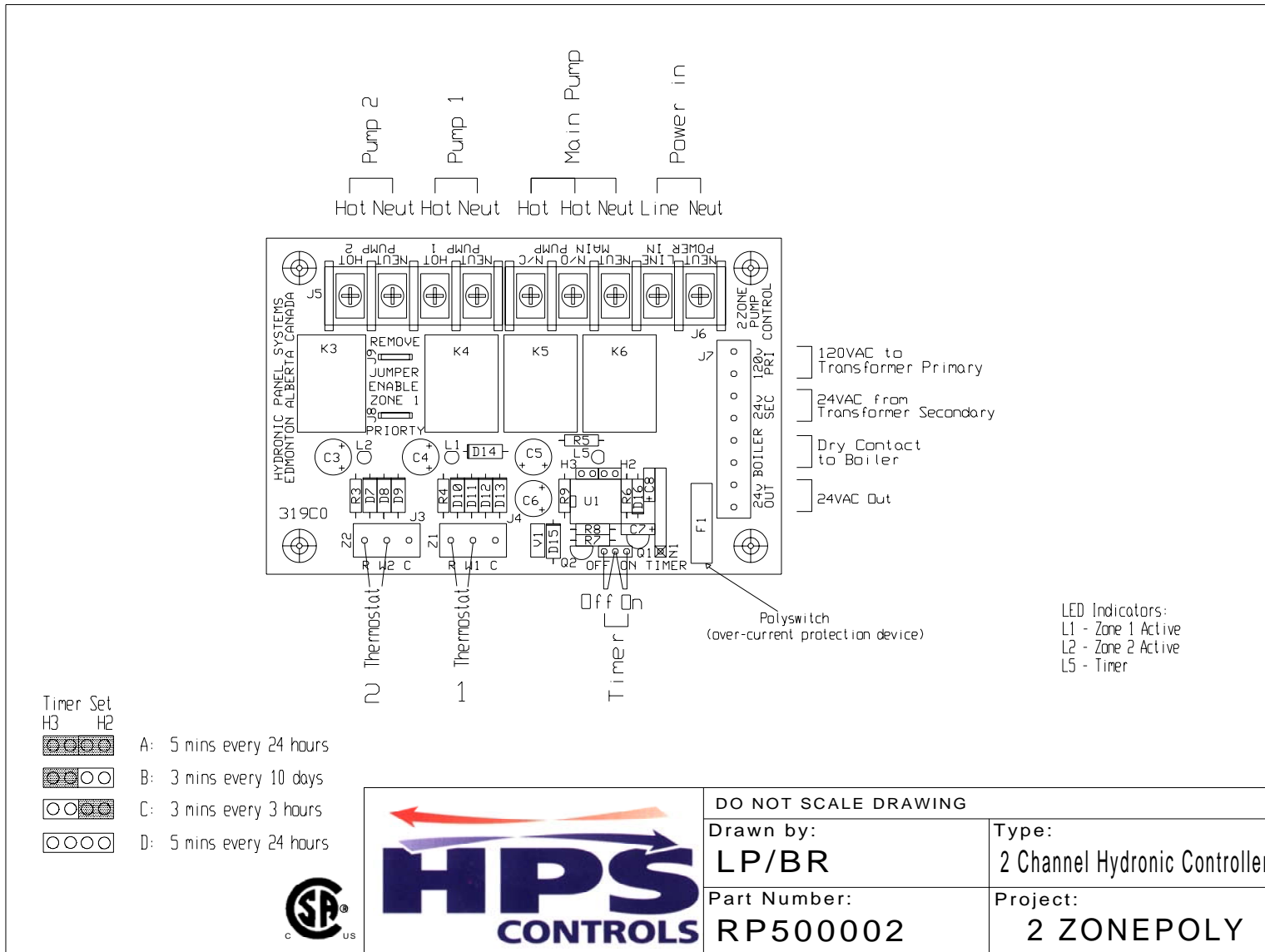

HPS Controls Ltd. Series 200 HTP

Diagram C (4-Zone Hydronic Controller)

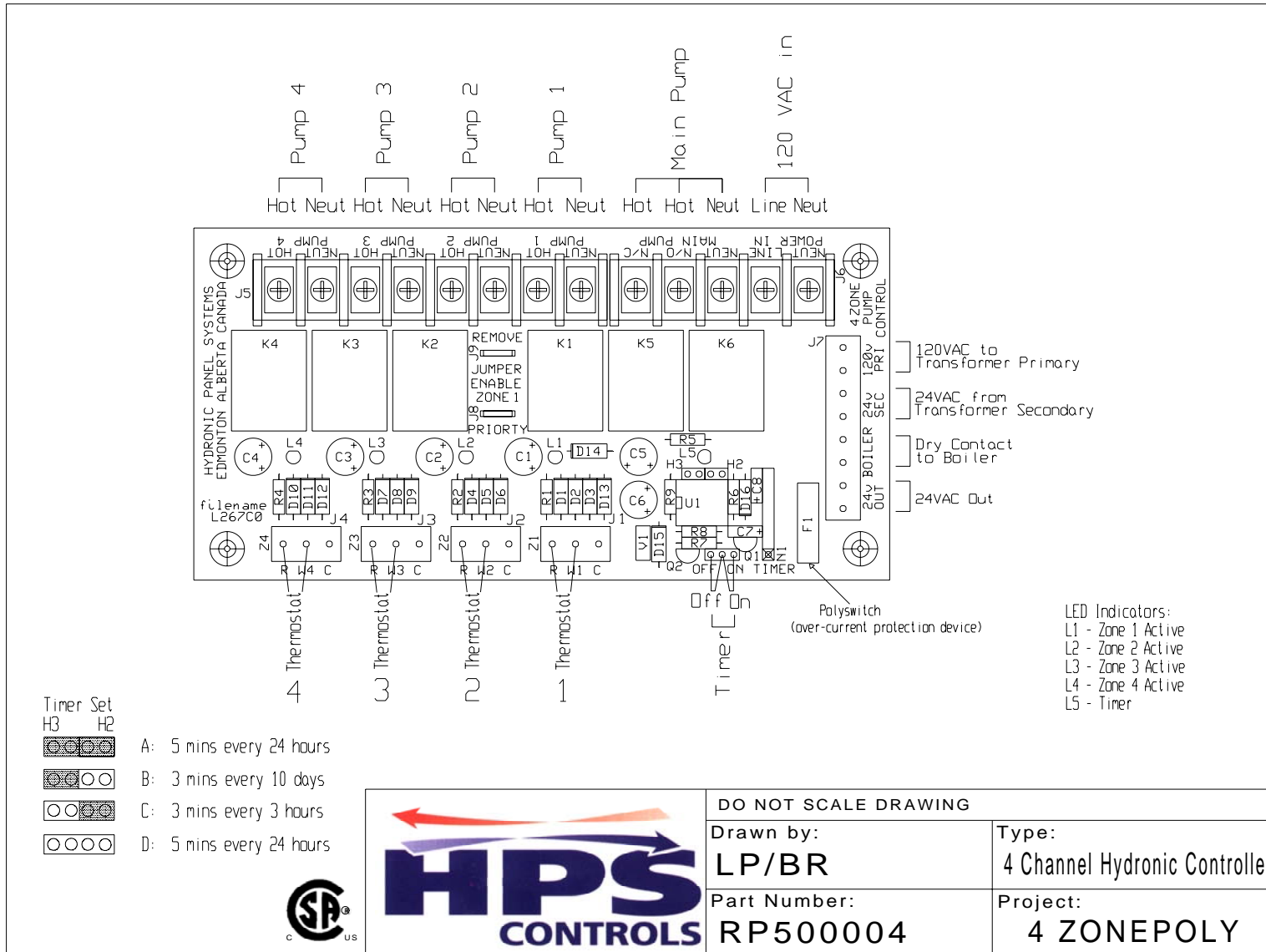

HPS Controls Ltd. Series 200 HTP

Diagram D (HTP Series)

HTP (HIGH TEMP STATIONS)

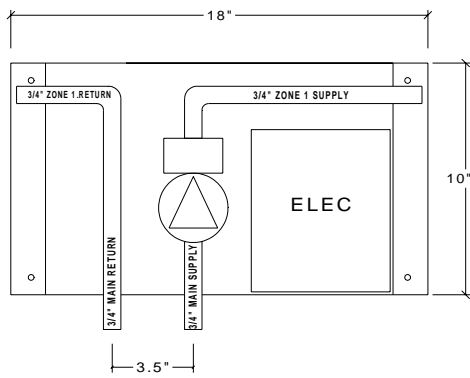

HTP-1

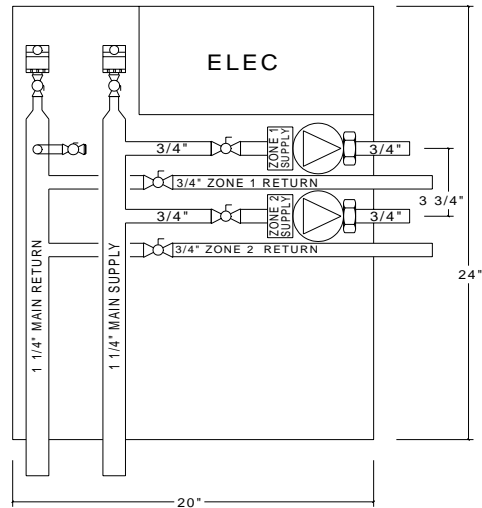

HTP-2

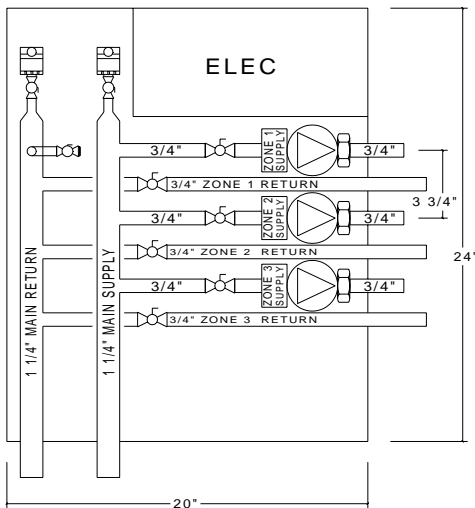



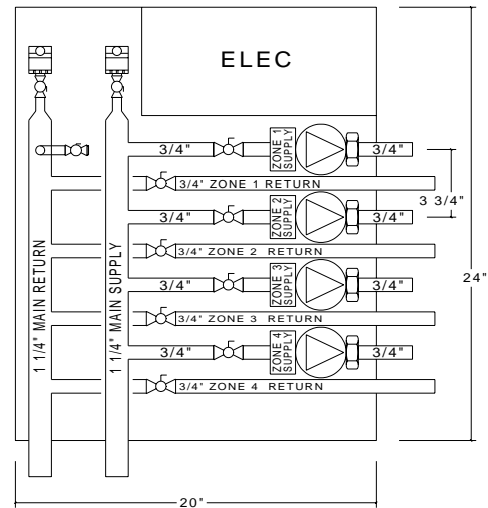

HTP-3



HTP-4

Legend

-  CIRCULATOR WITH SPRING CHECK VALVE
-  ISOLATION VALVE
-  PURGE VALVE
-  AUTO AIR VENT

HPS Controls Ltd. Series 200 HTP

Grundfos Pump Curves

UP 15-42 RUC7

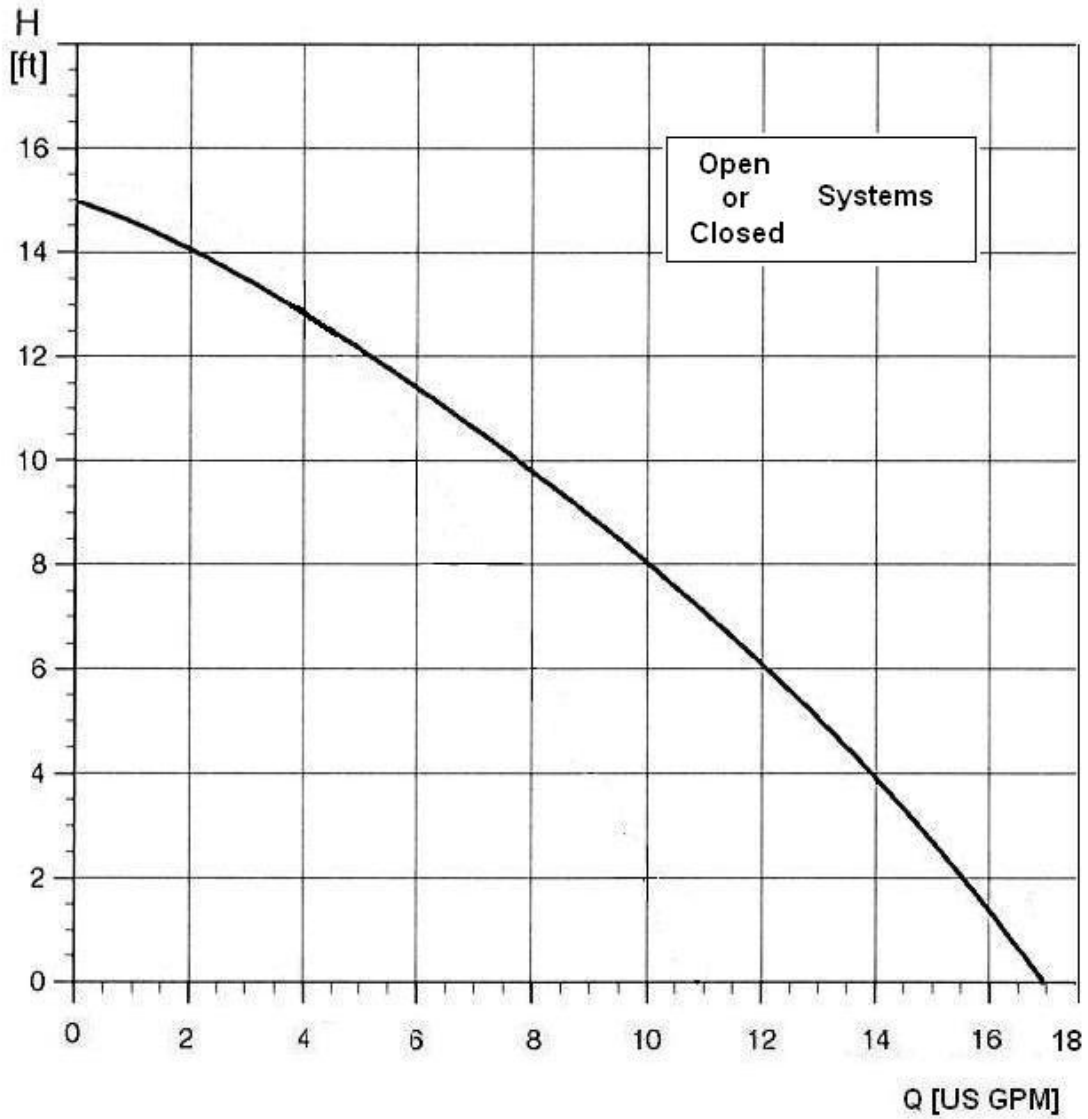

HPS Controls Ltd. Series 200 HTP

Warranty

Hydronic Zone Control Stations

LIMITED MANUFACTURER'S WARRANTY

We warrant products manufactured by HPS Controls to be free from defects for a period of one year from the date of purchase. In the event of any claim under this warranty or otherwise with respect to our products which is made within such period, we will at our options, repair or replace such products or refund the purchase price paid to us by you for such products. In no event shall HPS Controls be liable for any other loss or damage, whether direct, indirect, incidental, or consequential. This warranty is your exclusive remedy and shall be in place of any other warranty or guarantee, express or implied, including, without limitation, any warranty of merchantability or fitness for a particular purpose. This warranty may not be assigned or transferred and any unauthorized transfer or assignment thereof shall be void and of no force or effect.

CONDITIONS OF SALE

- TERMS:** Net 30 days. Invoice date is the date of shipment. Subject to credit approval. Past due invoices are subject to 2% per month (24% per annum) late charge.
- RETURNS:** Factory authorization is required prior to any return, the return must be made within (30) days of such authorization. Product to be returned must be shipped freight prepaid, and is subject to a 25% handling charge. RGA form required with serial number, proof of purchase date and a detailed description of problem.
- CLAIMS:** Claims for shortage or error in shipment must be made within (5) days of receipt. Claims for damage or loss in transit must be made directly to the delivering carrier.



10683 – 214 Street
EDMONTON, ALBERTA, CANADA T5S 2A2

Phone: 780-482-1051
800-708-1051
Fax: 780-482-3143
e-mail: hpsinfo@hpscontrols.com

Website: www.hpscontrols.com

